

VT 780 PTZ HD *camera system* brochure



VT 780 PTZ HD – FullHD inspection camera

Radiation resistant & watertight FullHD camera with integrated dimmable lighting, pan and tilt function, with slipping clutch and zoom function

Applications

- ▶ All underwater inspections and monitoring applications
- ▶ Nuclear applications (refueling - offloading - maintenance)
- ▶ Industrial applications
- ▶ Decommissioning applications

Features

- ▶ Robust design in anodized aluminum
- ▶ Pan & tilt including slipping clutch
- ▶ Radiation tolerant
- ▶ Zoom lens 30x optical / 12x digital
- ▶ 1080i/60 fps Full-HD resolution
- ▶ Integrated LED lighting
- ▶ Watertight up to 50 m
- ▶ Optional with 2 line lasers

Technical specifications - VT 780 PTZ HD camera

This document is for general information only, please consult the system manual for detailed specifications

Housing	anodized aluminum
Image sensor / number of effective pixels	CMOS / 2130k pixels
Output pixels (HxV)	1920x1080
Signal system	1080i/60
Minimum illumination	0.01 lx
Optical zoom	30x
Digital zoom	12x
Focus	automatic or manual
FOV	63.7° (wide) to 2.3° (tele)
Minimum object distance	10 mm (wide) to 1200 mm (tele)
Video output	Y/Pb/Pr
Range - PAN	infinite
Range - TILT	220° (± 110°)
Lighting	4x LED spots
Luminous flux	~ 6,000 lm
Dimension (LxWxø)	246.5x117x129 mm
Weight	3.5 kg
Operating temperature	---
Water tight / water depth	5 bar / 50 m
Radiation tolerant	7,000 rad/h (70 Gy/h)
Total dose	42,000 rad (420 Gy)
Optionals	laser modul for measurement applications
Features	integrated slipping clutch for pan & tilt

* unit in mm

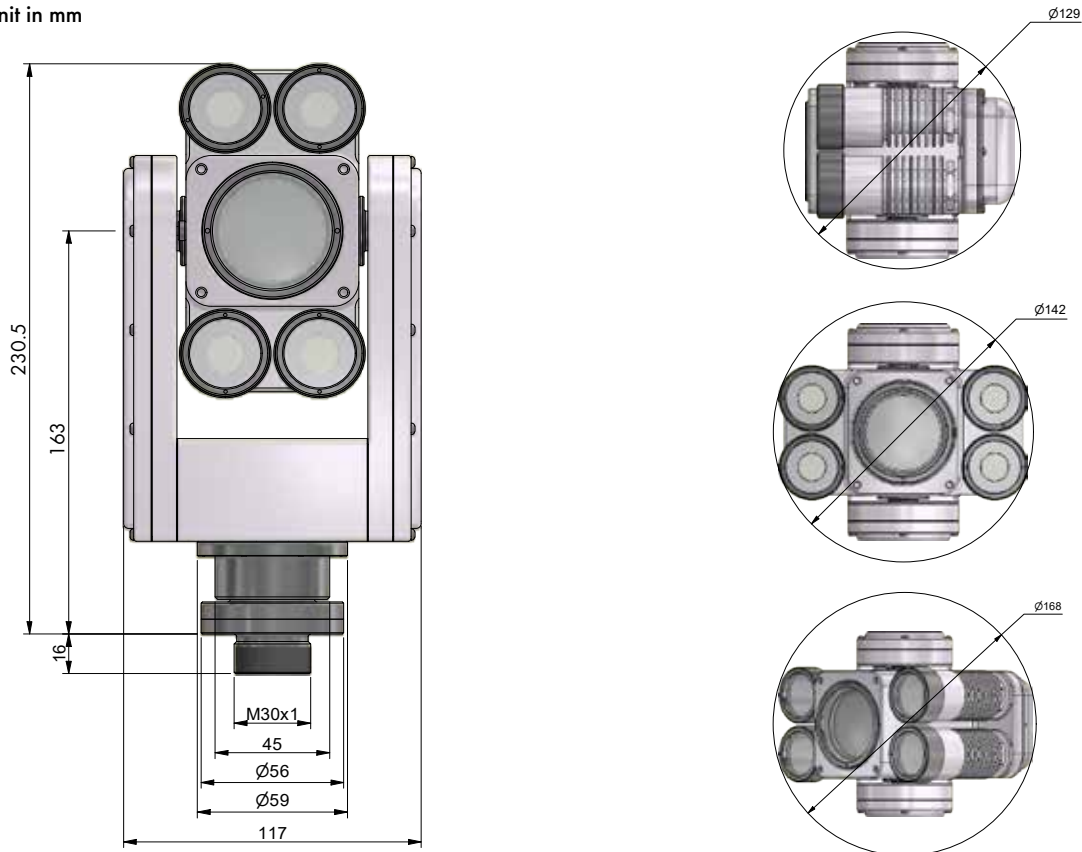

Setup

Possible combinations



Stand-alone system

DIN rail 35 mm compatible and modular control unit

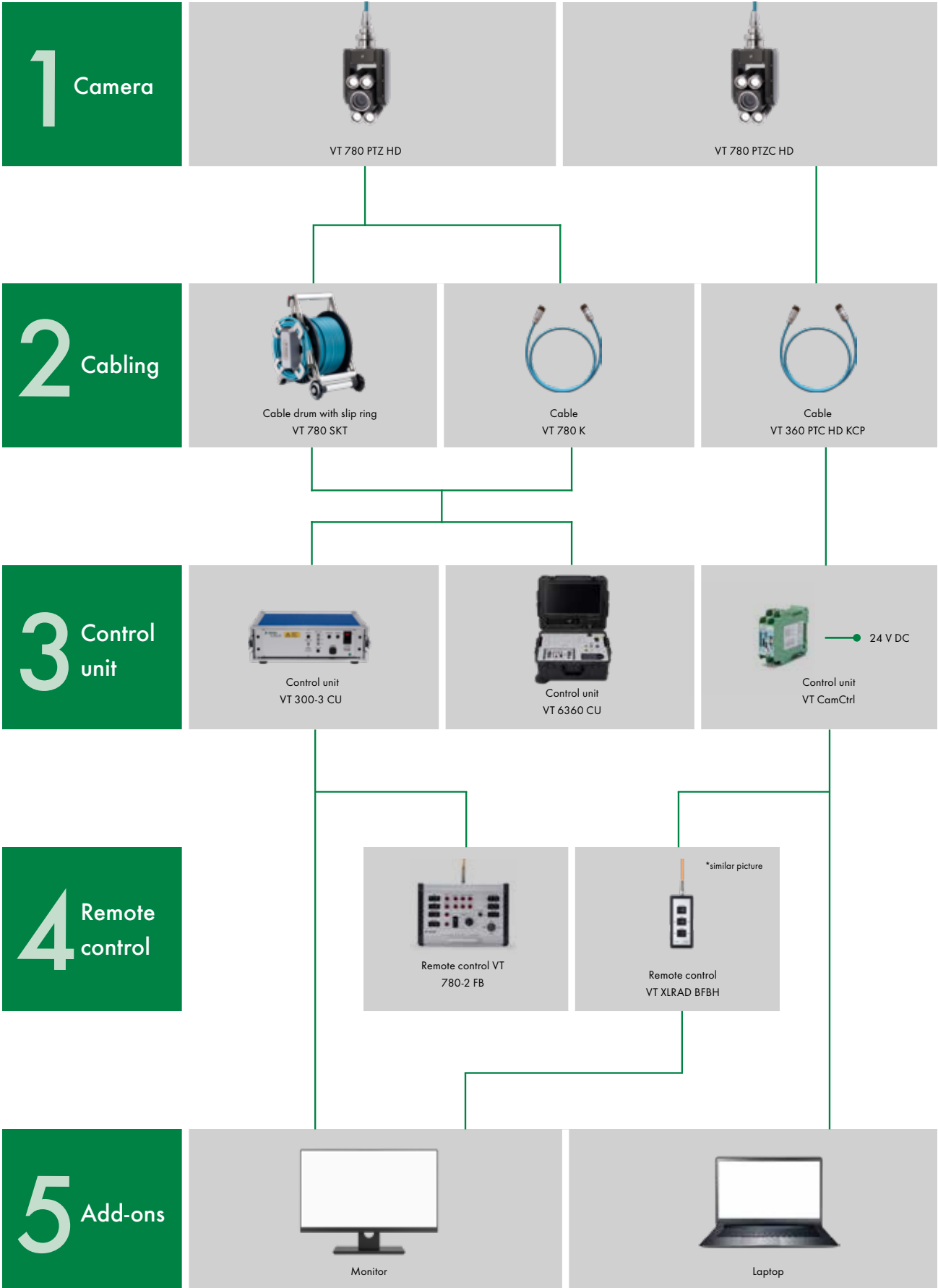

Optional equipment and accessories



VT 780 PTZL HD camera with 6-LED setup

Camera equipped with 4 floodlights for proper illumination of the surroundings and 2 spots for perfect lighting conditions in the distance



VT 780 PTZL HD camera with laser module

Laser generator to display reference lines for measurement software (available only with aluminum body)

Accessories



VT 29 carbon poles - 29 or 42 mm diameter

Connectable carbon poles for deployment of cameras and tools - standard lengths are 1 and 2 m



Manhole holder

Versatile positioner for 29 or 42 mm carbon poles



VT 72 holder

Holder for mounting the camera with VT 29 GR carbon poles



VT GH Vario tool holder

Variable railing bracket with stainless steel adapter for connecting the camera to 29 or 42 mm diameter carbon poles

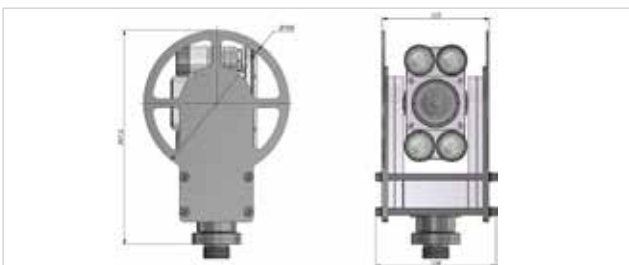

Protective bracket

Stainless steel protection bracket to protect the camera from external forces

DEKRA Visatec GmbH

Gewerbepark 7, 87477 Sulzberg/See
Germany
Tel. + 49.8376.9215 0
info.dvg@dekra.com

www.dekra-visatec.com

